

GTLP-3PT Push Knob Bar Latch

Features

- Suitable for tall cabinet doors
- Centre latch with dead bolt, top and bottom cams
- Door will be locked when knob is pushed in
- Applicable from 19 mm to 30 mm door thickness
- Able to install for both inset and overlay door
- Non-handed

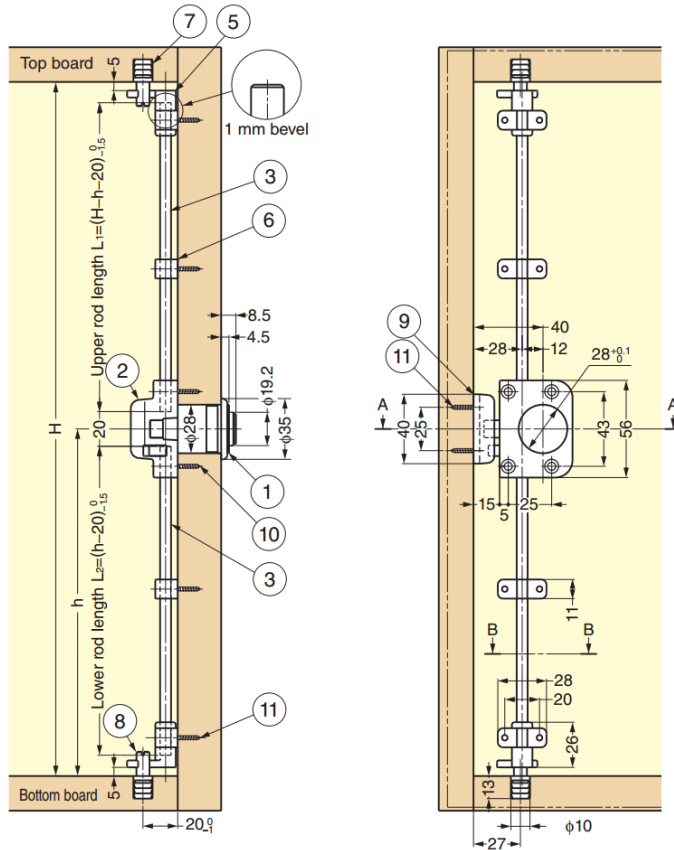
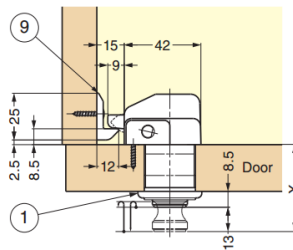
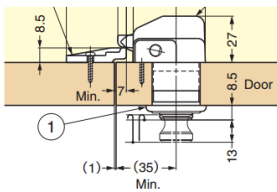
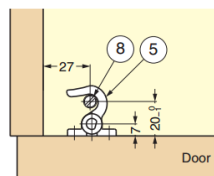
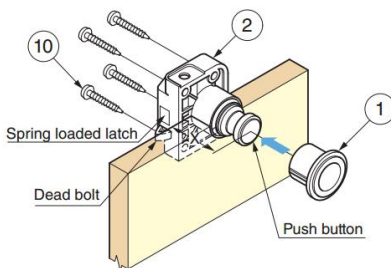

Plate for Swing Door



A-A cross section



B-B cross section

X Dimension

Screw Length	Door Thickness	X
ℓ = 24	19	40.5
ℓ = 24	20	41.5
ℓ = 24	21	42.5
ℓ = 24	22	43.5
ℓ = 24	23	44.5
ℓ = 24	24	45.5
ℓ = 30	25	46.5
ℓ = 30	26	47.5
ℓ = 30	27	48.5
ℓ = 30	28	49.5
ℓ = 30	29	50.5
ℓ = 30	30	51.5

Bore Dimension (Door)

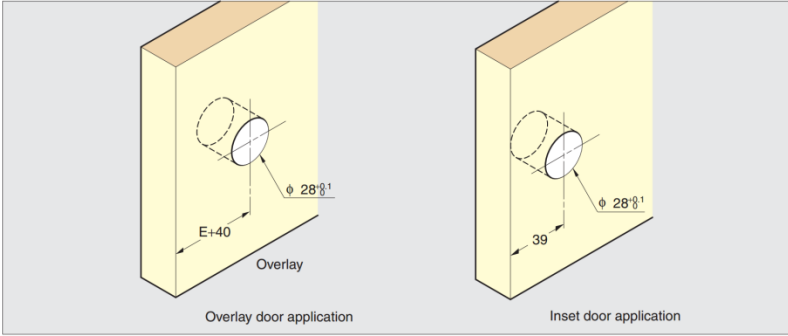

Bore Dimension (Cabinet)

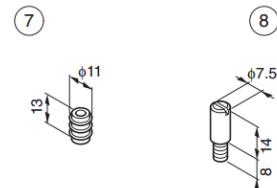
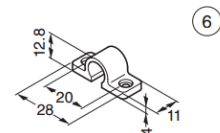
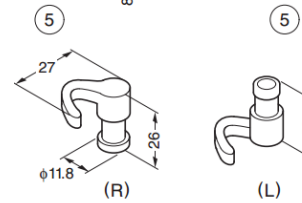
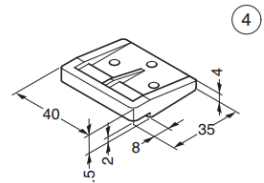
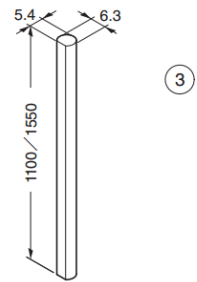
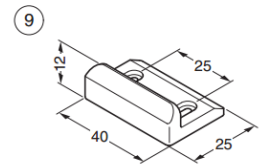
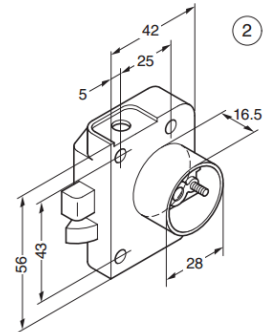
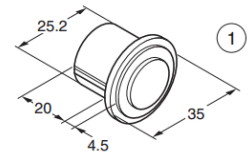
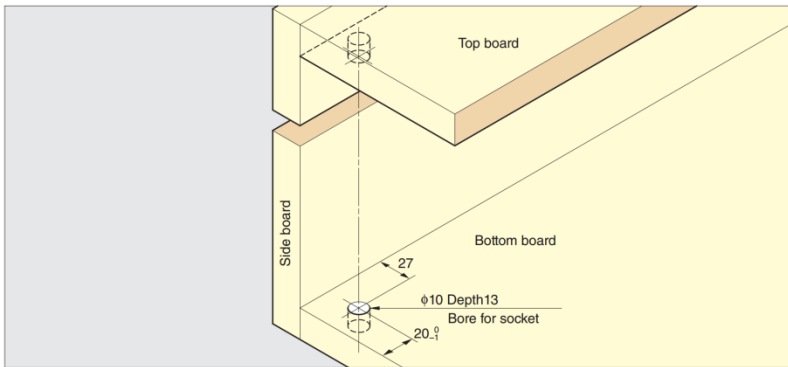

Part No.	No.	Description	Door Thickness	Material	Finish	Required Quantity
GTLP-SG	①	Push Button	19 ~ 30	Zinc Alloy, Brass	Satin Gold	1 pc
GTLP-WB					Satin Nickel	
GTLP-G					Gold	
GTLP-CR					Chrome	
GTLP-W	②	Latch Body	-	Polyamide	White	1 pc
GTLF-1100	③	Prop (Length: 1100)		Steel	Nickel	2 pcs
GTLF-1550		Prop (Length: 1550)				
GTLF-ST03W	④	Counter Plate for Double Swing Door		Polyamide	White	1 pc
GTLPP-W	⑤ ~ ⑧,	Parts Set (White)	As Below	As Below	As Below	1 set
GTLPP-BR	⑩					

Parts Included in ②

No.	Part Name	Qty	Material	Finish/Colour
⑨	Counter Plate	1 pc	Polyamide (PA)	White
⑩	Pan Head Tapping Screw 3×20	4 pcs	Steel	Yellow Zinc Chromate
⑪	Pan Head Tapping Screw 3×16	2 pcs	Steel	Yellow Zinc Chromate

Details of ⑤~⑧, ⑩

No.	Part Name	Qty	Material	Finish/Colour
⑤	Hook	Left and Right each 1 pc	Polyacetal (POM)	White/Brown
⑥	Holder	4 pcs	Polyamide (PA)	White/Brown
⑦	Socket M6	2 pcs	Polyamide (PA)	White/Brown
⑧	Striker (M6 Screw)	2 pcs	Steel	Nickel
⑩	Pan Head Screw 3×16	8 pcs	Steel	Yellow Zinc Chromate